

DATA SHEET

revision date
24.06.2024

product code

20.10.02.02.FF

20.10.02.03.FF

20.10.02.02.FD

20.10.02.03.FD

Satellite Clean FOAM DOUBLE PLUS Satellite Clean FOAM DOUBLE PLUSi

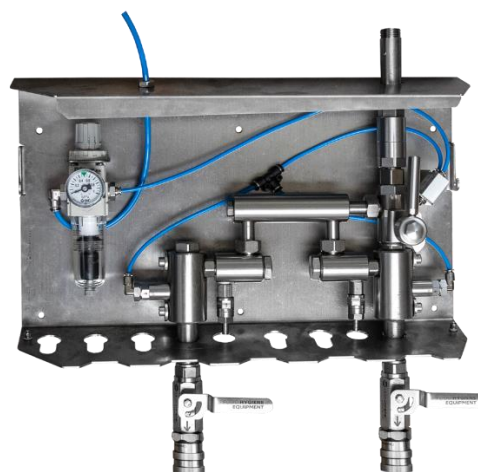

304



MATERIAL	Stainless Steel housing and connections
WEIGHT	10 kg
MAX. DIMENSIONS (WxHxD)	470 x 430 x 130 mm
MOUNTING HOLES DIAMETER AND SPACING (WxH)	ø7 mm; 2 x 205 x 190 mm
DOSING RANGE	0,3-8%
MIN. WATER FLOW FEED	30 l/min
WATER INLET	EXT 1/2"
WATER OUTLET	Female quick coupling 1/2"
WATER PRESSURE	18 - 40 bar
AIR OUTLET	ø6 mm
MIN. AIR FLOW (FEED)	150 l/min
AIR PRESSURE (FEED)	5 - 8 bar
NUMBER OF PIECES IN THE PACKAGE	1

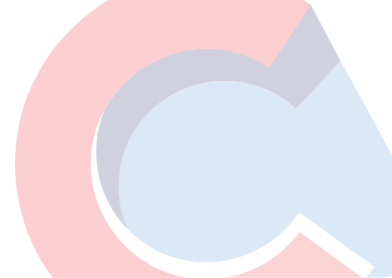

Clean **FOAM DOUBLE PLUS**

Clean **FOAM DOUBLE PLUSi**

CODE	NAME
20.10.02.02.FF	Satellite Clean FOAM DOUBLE PLUS - two foaming chemicals, concentration setting with a nozzles
20.10.02.03.FF	Satellite Clean FOAM DOUBLE PLUSi - two foaming chemicals, concentration setting with a needle valve
20.10.02.02.FD	Satellite Clean FOAM DOUBLE PLUS - two foaming/disinfection chemicals, concentration setting with a nozzles
20.10.02.03.FD	Satellite Clean FOAM DOUBLE PLUSi - two foaming/disinfection chemicals, concentration setting with a needle valve

- Satellite for 2 foaming chemicals or 2 foaming/disinfectant chemicals.
- The dosing of the chemical agent in the PLUS version takes place through the nozzles and in the PLUSi version - concentration setting with a needle valve.
- It has an air reducer equipped with a pressure gauge and liquid separator.
- Easy to use with a reliable manual control mechanism (functions: foam (for chemical agents) /water (for rinsing).
- Equipped with ULTRA HYGIENIC® stainless steel ball valve with female quick coupling.
- Chemical agent, water and air suction inlets are secured with stainless steel check valves.
- Dryer and pressure gauge protected by a stainless steel housing.
- Laser marking available on request.
- Durable, safe and hygienic stainless steel housing.
- Can be installed in narrow spaces as no need to leave any space for service on the sides of the device.
- Possibility to install the satellite on a wall or on a mobile washing point.
- Protection of service elements against unauthorized access.
- The sloping roof and the bottom of the satellite (15°) prevents accumulation of sediments.
- Easy access to the injector.
- There are 4 holes for hanging lances in the lower part of the housing.
- The back satellite wall has 4 mounting holes.
- The bottom of the satellite designed for hanging lances and a suction tube.
- Satellite equipped with automatic shut-off valve for compressed air supply.



DIFFERENCES

Clean FOAM DOUBLE PLUS

The dosing of the chemical agent through the nozzle:

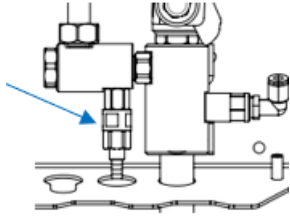

Clean FOAM DOUBLE PLUSi

The dosing of the chemical agent— concentration setting with a needle valve:

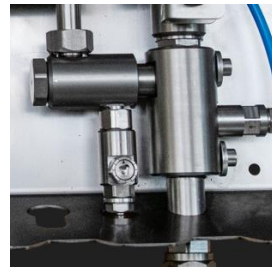
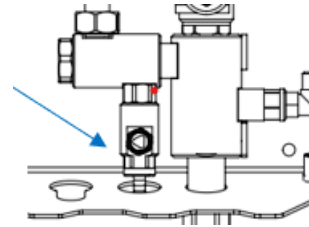

AUTOMATIC SHUT-OFF VALVE FOR COMPRESSED AIR SUPPLY

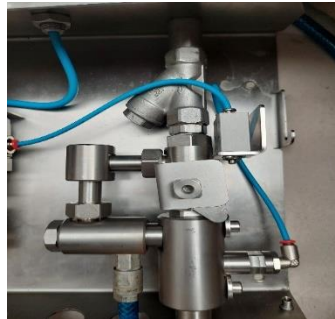

AUTOMATIC SHUT-OFF VALVE FOR COMPRESSED AIR SUPPLY - DIAGRAM

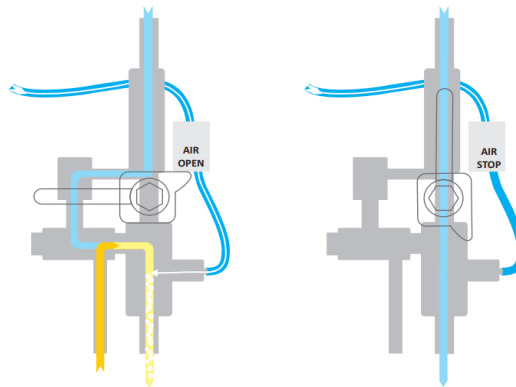



TECHNICAL DRAWINGS WITH DIMENSIONS

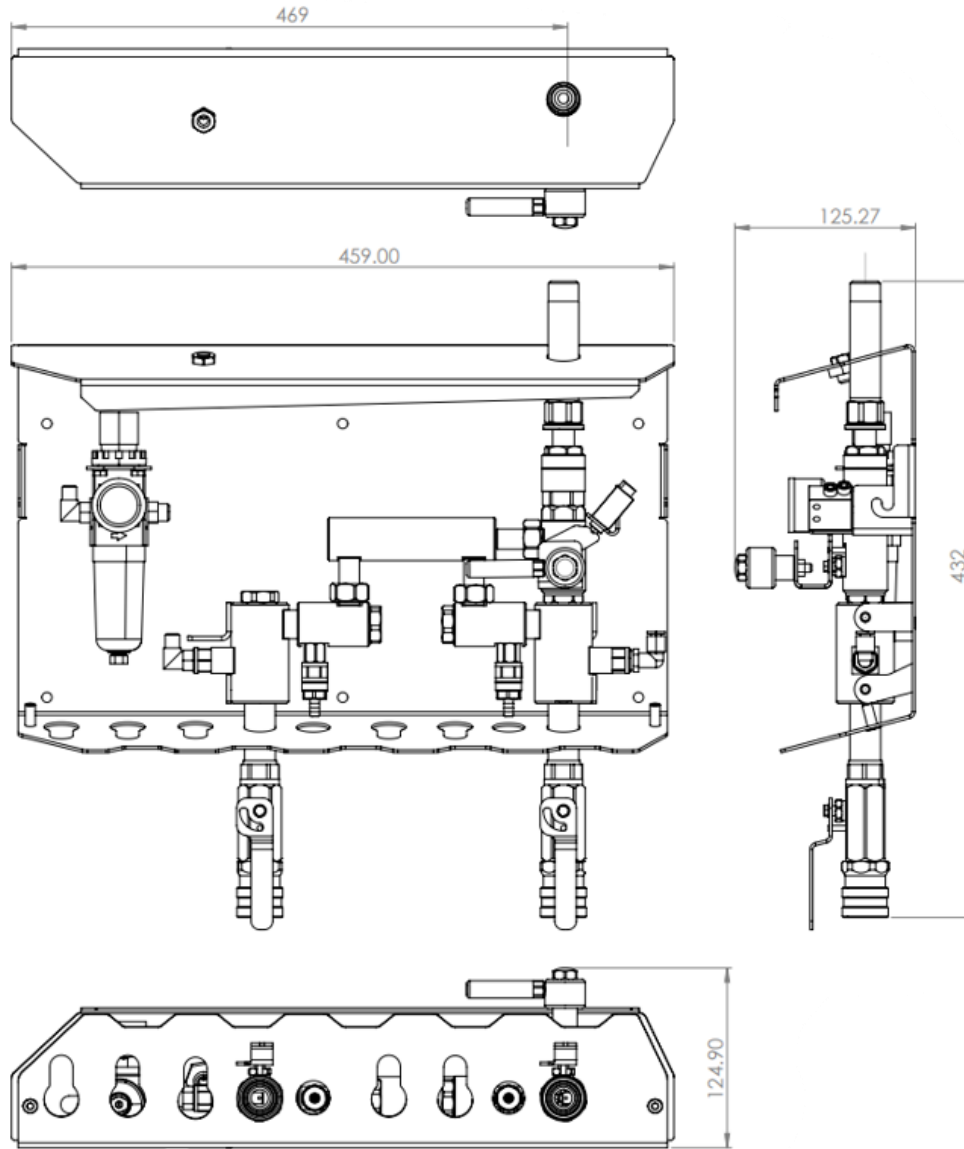

MAINTENANCE

The housing is made of stainless steel. Its anti-corrosion properties depend on the conditions in which the steel is used and its maintenance. Stainless steel products should be cleaned, dried and maintained with products intended for this purpose. Particular attention should be paid to the regime of cleaning for products used in an environment of high salinity or humidity to prevent sediments accumulation.

REMEMBER! RINSE THE DEVICE WITH CLEAN WATER AFTER USE

The suction tube, which is used to transfer the chemical agent from the canister should be immersed in clean water and the device should be run in the FOAM position until clean water is obtained at the exit of the lance.